

Elektrické predĺžovacie prívody sú určené pre pripojenie prenosných elektrických zariadení.

Sú vyrábané vo viacerých typových variantách odlišujúcich sa dĺžkou a vlastnosťami použitého kábla, počtom zásuviek na bubne a ich menovitou prívodovou hodnotou.

Sú vyrábané v zhode s technickými požiadavkami podľa STN EN 61242 a STN EN 61316.

MULTIPLE séria je rada kvalitných a dizajnovo prítiahlivých predĺžovacích káblov s viacnásobnými zásuvkami pre domové a kancelárske použitie v štyroch farebných prevedeniach.

TRIS séria ponúka prevedenia jednoduchých predĺžovacích bubnov pre domové a kancelárske využitie.

ROLLER 330 je séria kvalitných a účelových káblových bubnov s domovými a priemyselnými zásuvkami pre všeobecné použitie

ROLLER 450 káblové bubny s domovými a priemyselnými zásuvkami pre použitie v priemysle. Ponuka je rozšírená aj o prevedenie na kolieskach.

AUTOROLLER séria ponúka samonavíjacie bubny pre miesta, kde sa vyžaduje pevné upevnenie predĺžovacieho prívodu.

- **Prázdne bubny**
- **Bubny 230V/16A**
- **Bubny 400V/16A a 32A**
- **Bubny 400V istené**
- **Bubny 230V samonavíjacie**

### 3. PREDĽŽOVACIE PRÍVODY



## Séria MULTIPLE

Referenčné normy: IEC 60 884-1

### VIACNÁSOBNÉ ZÁSUVKY

- biela
- F  dymová transparentná
- N  čierna
- T  transparentná modrá



#### Bez vypínača

Popis zásuvky	Farba	Balenie	Katalógové číslo
4x2P+T - 16A (French Standard)	<input type="checkbox"/>	1/10	160.247
	<input type="checkbox"/>	1/10	160.247/F
	<input type="checkbox"/>	1/10	160.247/N
	<input type="checkbox"/>	1/10	160.247/T



#### S vypínačom

Popis zásuvky	Farba	Balenie	Katalógové číslo
4x2P+T - 16A (French Standard)	<input type="checkbox"/>	1/10	160.248
	<input type="checkbox"/>	1/10	160.248/F
	<input type="checkbox"/>	1/10	160.248/N
	<input type="checkbox"/>	1/10	160.248/T

### PRÍSLUŠENSTVO



#### Držiak na upevnenie viacnásobnej zásuvky

Popis	Farba	Balenie	Katalógové číslo
Držiak 2 ks v balení	<input type="checkbox"/>	1/10	160.001

Spôsob upevnenia viacnásobnej zásuvky pomocou príslušenstva 160.001



## Séria ROLLER

### KÁBLOVÉ BUBNY ROLLER 330 PRÁZDNE + ČELÁ



#### Prázdny bubon bez čela

Popis	Katalógové číslo
Štandardný	SC92062
S úchytom pre Block 4	SC92064



#### Čelo k bubnu ROLLER 330

Otvory	Katalógové číslo
Bez otvoru	SC92068
1 x voľný prívod	SC91276
2 x 16A/400V (2x16A/230V)	SC92081
2 x 16/32A/400V pre 422.xxxx	SC91999
4 x 16A/230V zásuvky	SC92073
2 x 16/32A/400V pre 422.xxxx + 1x 16A/230V	SC92077
1 x 16A/400V (1x16A/230V)	SC92084

Referenčné normy: IEC 60 884-1

### VIACNÁSOBNÉ ZÁSUVKY S KÁBLOM

H05 VV-F (PVC) 3x1 mm<sup>2</sup>



#### Bez vypínača

Popis zásuvky	Dĺžka kábla	Farba	Balenie	Katalógové číslo
4x2P+T - 10A (French Standard)	3 m	<input type="checkbox"/>	1/10	160.247/C3
		<input type="checkbox"/>	1/10	160.247/C3-F
		<input type="checkbox"/>	1/10	160.247/C3-N
		<input type="checkbox"/>	1/10	160.247/C3-T
	5 m	<input type="checkbox"/>	1/10	160.247/C5
		<input type="checkbox"/>	1/10	160.247/C5-F
		<input type="checkbox"/>	1/10	160.247/C5-N
		<input type="checkbox"/>	1/10	160.247/C5-T



#### S vypínačom

Popis zásuvky	Dĺžka kábla	Farba	Balenie	Katalógové číslo
4x2P+T - 10A (French Standard)	3 m	<input type="checkbox"/>	1/10	160.248/C3
		<input type="checkbox"/>	1/10	160.248/C3-F
		<input type="checkbox"/>	1/10	160.248/C3-N
		<input type="checkbox"/>	1/10	160.248/C3-T
	5 m	<input type="checkbox"/>	1/10	160.248/C5
		<input type="checkbox"/>	1/10	160.248/C5-F
		<input type="checkbox"/>	1/10	160.248/C5-N
		<input type="checkbox"/>	1/10	160.248/C5-T

## Séria ROLLER

### KÁBLOVÉ BUBNY ROLLER 450 PRÁZDNE + ČELÁ

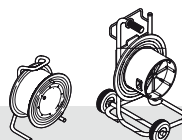

#### Prázdny bubon bez čela

Popis	Katalógové číslo
Štandardný	SC92065
Na kolieskach s úchytom pre Block 4	SC92066



#### Čelo k bubnu ROLLER 450

Otvory	Katalógové číslo
Bez otvoru	SC92088
1 x 16/32A zásuvka pre 422.xxxx	SC92087
3 x 16A zásuvka pre 412.xxxx	SC92093
4 x 16/32A zásuvka pre 422.xxxx	SC92090

## KÁBLOVÉ BUBNY PREDLŽOVACIE







Referenčné normy: EN 61242

## SÉRIA TRIS

Prevádzková teplota: -5 °C do + 40 °C



## Káblový bubon s domovými zásuvkami

Zásuvky IP20				Vidlica 16A	Kábel H05 VV-F 3Gx1,5 (PVC)	Dĺžka kábla v metroch	Pmax (W)		Napätie (V~)	Katalógové číslo
250V / 16A domová	250V / 16A priemyselná	400V/16A	400V/16A							
 2P+E	 2P+E	 3P+E	 3P+N+E							
4				2P+E	3x1,5	10	1200	3200	230	709.3810
4				2P+E	3x1,5	20	1500	3200	230	709.4820

## KÁBLOVÉ BUBNY S DOMOVÝMI ZÁSUVKAMI

Referenčné normy: EN 61242

## SÉRIA ROLLER 330

Prevádzková teplota: -25 °C do +60 °C

Mechanická odolnosť pri teplote 20 °C: IK 07

Materiál bubna odolný UV žiareniu

Cievka bubna: Ø 330 mm









742.244/15-40m



742.152/25-25m

## Káblový bubon s domovými zásuvkami 230V-16A

Zásuvky IP44				Vidlica domová 16A	Dĺžka kábla v metroch	Pmax (W)		Napätie (V~)	Katalógové číslo podľa typu kábla		
250V / 16A domová	250V / 16A priemyselná	400V/16A	400V/16A						H05 VV-F3G1,5 (PVC 3x1,5)	H05 RR-F-3G1,5 (Guma 3x1,5)	H05 RR-F-3G2,5 (Guma 3x2,5)
 2P+E	 2P+E	 3P+E	 3P+N+E								
2				2P+E	25	1300	3600	230	742.242/15/V-25m	742.242/15-25m	742.242/25-25m
2				2P+E	30	1300	3600	230	742.242/15/V-30m	742.242/15-30m	742.242/25-30m
2				2P+E	35	1300	3600	230	742.242/15/V-35m	742.242/15-35m	742.242/25-35m
2				2P+E	40	1300	3600	230	742.242/15/V-40m	742.242/15-40m	742.242/25-40m
2				2P+E	50	1300	3600	230	742.242/15/V-50m	742.242/15-50m	742.242/25-50m
4				2P+E	25	1300	3600	230	742.244/15/V-25m	742.244/15-25m	742.244/25-25m
4				2P+E	30	1300	3600	230	742.244/15/V-30m	742.244/15-30m	742.244/25-30m
4				2P+E	35	1300	3600	230	742.244/15/V-35m	742.244/15-35m	742.244/25-35m
4				2P+E	40	1300	3600	230	742.244/15/V-40m	742.244/15-40m	742.244/25-40m
4				2P+E	50	1300	3600	230	742.244/15/V-50m	742.244/15-50m	742.244/25-50m
1*				2P+E	25	1300	3600	230	742.152/15/V-25m	742.152/15-25m	742.152/25-25m
1*				2P+E	30	1300	3600	230	742.152/15/V-30m	742.152/15-30m	742.152/25-30m
1*				2P+E	35	1300	3600	230	742.152/15/V-35m	742.152/15-35m	742.152/25-35m
1*				2P+E	40	1300	3600	230	742.152/15/V-40m	742.152/15-40m	742.152/25-40m
1*				2P+E	50	1300	3600	230	742.152/15/V-50m	742.152/15-50m	742.152/25-50m

\* Zásuvka voľný prívod

# KÁBLOVÉ BUBNY S PRIEMYSELNÝMI ZÁSUVKAMI

Referenčné normy: EN 61316, EN 61242

## SÉRIA ROLLER 330

Prevádzková teplota: -25 °C do + 60 °C  
 Mechanická odolnosť pri teplote 20 °C: IK 07  
 Materiál bubna odolný UV žiareniu  
 Cievka bubna: Ø 330 mm



746.110/4-20m

## Káblový bubon 230/400V-16A

Zásuvky IP44				Vidlica 16A	Kábel H07RN-F (guma)	Dĺžka kábla v metroch	P <sub>max</sub> (W)		Napätie (V~)	Katalógové číslo
250V / 16A domová	250V / 16A priemyselná	400V/16A	400V/16A							
2P+E	2P+E	3P+E	3P+N+E							
		1		3P+E	4x2,5	20	4500	11000	400	746.100/4-20m
		1		3P+E	4x2,5	30	4500	11000	400	746.100/4-30m
			1	3P+N+E	5x2,5	20	5000	11000	400	746.100-20m
			1	3P+N+E	5x2,5	30	5000	11000	400	746.100-30m
		2		3P+E	4x2,5	20	4500	11000	400	746.110/4-20m
		2		3P+E	4x2,5	30	4500	11000	400	746.110/4-30m
			2	3P+N+E	5x2,5	20	5000	11000	400	746.110-20m
			2	3P+N+E	5x2,5	30	5000	11000	400	746.110-30m
1			1	3P+N+E	5x2,5	20	5000	11000	400	746.120-20m
1			1	3P+N+E	5x2,5	30	5000	11000	400	746.120-30m
	1		1	3P+N+E	5x2,5	20	5000	11000	400	746.140-20m
	1		1	3P+N+E	5x2,5	30	5000	11000	400	746.140-30m
1			2	3P+N+E	5x2,5	20	5000	11000	400	746.112-20m
1			2	3P+N+E	5x2,5	30	5000	11000	400	746.112-30m

## Séria ROLLER-BLOCK 330

### Séria ROLLER 330

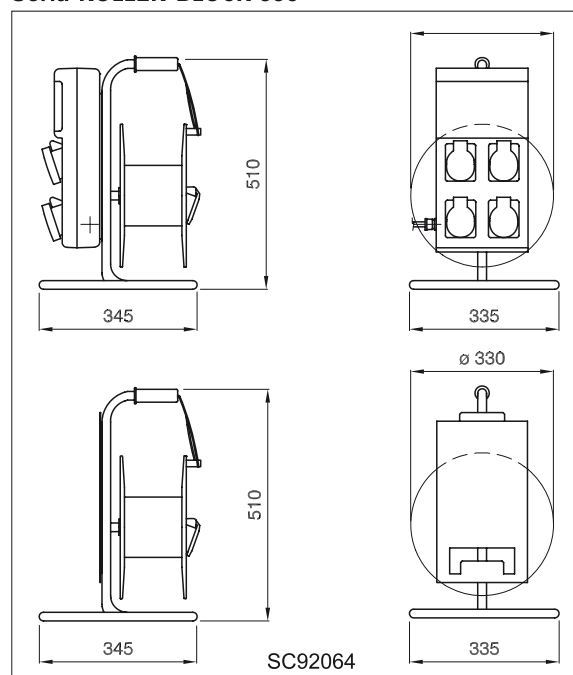
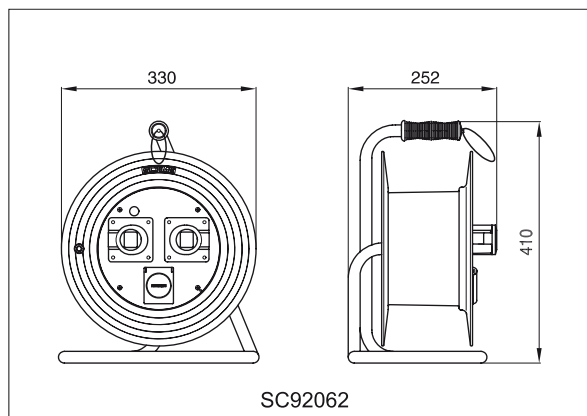

## KÁBLOVÉ BUBNY S PRIEMYSELNÝMI ZÁSUVKAMI

Referenčné normy: EN 61316, EN 61242







## SÉRIA ROLLER 450

Prevádzková teplota: -25 °C do + 60 °C  
 Mechanická odolnosť pri teplote 20 °C: IK 08  
 Materiál bubna odolný UV žiareniu  
 Cievka bubna: Ø 450 mm





745.111-50m

## Kábový bubon 230/400V-16A

Zásuvky IP44				Vídlica 16A	Kábel H07RN-F (guma)	Dĺžka kábla v metroch	Pmax (W)		Napätie (V~)	Katalógové číslo
250V / 16A domová	250V / 16A priemyselná	400V/16A	400V/16A							
				2P+E	3x2,5	50	1600	3600	230	745.222-50m*
	3			2P+E	3x2,5	50	1600	3600	230	745.444-50m*
			3	3P+N+E	5x2,5	50	4000	11000	400	745.111-50m
		3		3P+E	4x2,5	50	4000	11000	400	745.111/4-50m
2			1	3P+N+E	5x2,5	50	4000	11000	400	745.221-50m
1			2	3P+N+E	5x2,5	50	4000	11000	400	745.211-50m

\*Kábel H05 RR-F-3G2,5 (guma 3x2,5)

## Kábový bubon 400V-32A

Zásuvky IP44				Vídlica 32A	Kábel H07RN-F (guma)	Dĺžka kábla v metroch	Pmax (W)		Napätie (V~)	Katalógové číslo
250V / 16A domová	250V / 16A priemyselná	400V/32A	400V/32A							
			1	3P+N+E	5x4	50	7000	14000	400	745.300-50m
		1		3P+E	4x4	50	7000	14000	400	745.300/4-50m
			1	3P+N+E	5x4	40	7000	14000	400	745.300-40m
		1		3P+E	4x4	40	7000	14000	400	745.300/4-40m
			1	3P+N+E	5x4	30	7000	14000	400	745.300-30m
		1		3P+E	4x4	30	7000	14000	400	745.300/4-30m

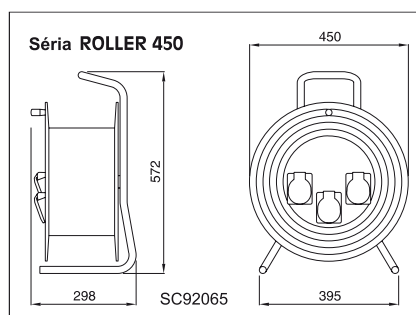

# KÁBLOVÉ BUBNY S PRIEMYSELNÝMI ZÁSUVKAMI

Referenčné normy: EN 61316, EN 61242

## SÉRIA ROLLER 450

Prevádzková teplota: -25 °C do + 60 °C  
 Mechanická odolnosť pri teplote 20 °C: IK 08  
 Materiál bubna odolný UV žiareniu  
 Cievka bubna: Ø 450 mm



749.111-50m

### Kábový bubon na kolieskach 230/400V-16A

Zásuvky IP44				Vidlica 16A	Kábel H07RN-F (guma)	Dĺžka kábla v metroch	Pmax (W)		Napätie (V~)	Katalógové číslo
250V / 16A domová	250V / 16A priemyselná	400V/16A	400V/16A							
				2P+E	3x2,5	50	1600	3600	230	749.222-50m*
	3			2P+E	3x2,5	50	1600	3600	230	749.444-50m*
			3	3P+N+E	5x2,5	50	4000	11000	400	749.111-50m
		3		3P+E	4x2,5	50	4000	11000	400	749.111/4-50m
2			1	3P+N+E	5x2,5	50	4000	11000	400	749.221-50m
1			2	3P+N+E	5x2,5	50	4000	11000	400	749.211-50m

\*Kábel H05 RR-F-3G2,5 (guma 3x2,5)

### Kábový bubon na kolieskach 400V-32A

Zásuvky IP44				Vidlica 32A	Kábel H07RN-F (guma)	Dĺžka kábla v metroch	Pmax (W)		Napätie (V~)	Katalógové číslo
250V / 16A domová	250V / 16A priemyselná	400V/32A	400V/32A							
			1	3P+N+E	5x4	50	7000	14000	400	749.300-50m
		1		3P+E	4x4	50	7000	14000	400	749.300/4-50m
			1	3P+N+E	5x4	40	7000	14000	400	749.300-40m
		1		3P+E	4x4	40	7000	14000	400	749.300/4-40m
			1	3P+N+E	5x4	30	7000	14000	400	749.300-30m
		1		3P+E	4x4	30	7000	14000	400	749.300/4-30m

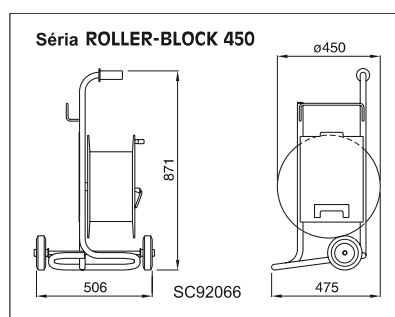



## KÁBLOVÉ BUBNY S PRIEMYSELNÝMI ZÁSUVKAMI

Referenčné normy: EN 61316, EN 61242

## SÉRIA ROLLER 450

Prevádzková teplota: -25 °C do + 60 °C

Mechanická odolnosť pri teplote 20 °C: IK 08

Materiál bubna odolný UV žiareniu









Cievka bubna: Ø 450 mm











745.332-50m

749.332-50m

## Káblový bubon 230/400V-16A a 400V-32A istený

Zásuvky IP44						Vídlica 16A	Vídlica 32A	Kábel HO7RN-F (guma)	Dĺžka kábla v metroch	Počet ističov "MCB"		Pmax (W)		Napätie (V~)	Katalógové číslo
250V / 16A domová	250V / 16A priemyselná	400V/16A	400V/16A	400V/32A	400V/32A					B16/1	C16/3				
							3P+N+E	5x4	50	1		7000	14000	230/400	745.320-50m
				1			3P+N+E	5x4	50	1		7000	14000	230/400	745.320/4-50m
					1		3P+N+E	5x4	50	1		7000	14000	230/400	745.322-50m
				1			3P+N+E	5x4	50	1		7000	14000	230/400	745.322/4-50m
			1		1		3P+N+E	5x4	50	1	1	7000	14000	230/400	745.312-50m
		1		1			3P+N+E	5x4	50	1	1	7000	14000	230/400	745.312/4-50m
			2		1		3P+N+E	5x4	50		1	7000	14000	400	745.311-50m
		2		1			3P+E	4x4	50		1	7000	14000	400	745.311/4-50m
1					2		3P+N+E	5x4	50	1		7000	14000	230/400	745.332-50m
1				2			3P+N+E	5x4	50	1		7000	14000	230/400	745.332/4-50m

## Káblový bubon na kolieskach 230/400V-16A a 400V-32A istený

Zásuvky IP44						Vídlica 16A	Vídlica 32A	Kábel HO7RN-F (guma)	Dĺžka kábla v metroch	Počet ističov "MCB"		Pmax (W)		Napätie (V~)	Katalógové číslo
250V / 16A domová	250V / 16A priemyselná	400V/16A	400V/16A	400V/32A	400V/32A					B16/1	C16/3				
							3P+N+E	5x4	50	1		7000	14000	230/400	749.320-50m
				1			3P+N+E	5x4	50	1		7000	14000	230/400	749.320/4-50m
					1		3P+N+E	5x4	50	1		7000	14000	230/400	749.322-50m
				1			3P+N+E	5x4	50	1		7000	14000	230/400	749.322/4-50m
			1		1		3P+N+E	5x4	50	1	1	7000	14000	230/400	749.312-50m
		1		1			3P+N+E	5x4	50	1	1	7000	14000	230/400	749.312/4-50m
			2		1		3P+N+E	5x4	50		1	7000	14000	400	749.311-50m
		2		1			3P+E	4x4	50		1	7000	14000	400	749.311/4-50m
1					2		3P+N+E	5x4	50	1		7000	14000	230/400	749.332-50m
1				2			3P+N+E	5x4	50	1		7000	14000	230/400	749.332/4-50m

## KÁBLOVÉ BUBNY S PRIEMYSELNÝMI ZÁSUVKAMI

Referenčné normy: EN 61316, EN 61242

### SÉRIA ROLLER 450

Prevádzková teplota: -25 °C do + 60 °C  
 Mechanická odolnosť pri teplote 20 °C: IK 08  
 Materiál bubna odolný UV žiareniu  
 Cievka bubna: Ø 450 mm



#### Káblový bubon na kolieskach pre napojenie zásuvkovej rozvodnice

Zásuvky IP44				Vidlica 16A	Kábel H07RN-F (guma)	Dĺžka kábla v metroch	Pmax (W)		Napätie (V~)	Katalógové číslo
250V / 16A domová	250V / 16A priemyselná	400V/16A	400V/16A							
				2P+E	3x2,5	50			230	749.2000-50m
	1			2P+E	3x2,5	50			230	749.4000-50m
		1		3P+E	4x2,5	50			400	749.1000/4-50m
			1	3P+N+E	5x2,5	50			400	749.1000-50m

\* Block 4 nie je súčasťou bubna.

## KÁBLOVÉ BUBNY AUTOROLLER

Referenčné normy: IEC 61242, IEC 61316

### Káblový bubon samonavíjací



Zásuvky IP20				Vidlica 16A	Kábel H05VV-F	Dĺžka kábla v metroch	Pmax (W)		Napätie (V~)	Katalógové číslo
250V / 16A domová	250V / 16A priemyselná	400V/16A	400V/16A							
				2P+E	3x1,5	12			230	751.1315-DZ
				2P+E	3x2,5	8			230	751.0325-DZ



### Káblový bubon samonavíjací s prenosným svetidlom 230V / 60W / IP20

Zásuvky IP20				Vidlica 16A	Kábel H05VV-F	Dĺžka kábla v metroch	Pmax (W)		Napätie (V~)	Katalógové číslo
250V / 16A domová	250V / 16A priemyselná	400V/16A	400V/16A							
				2P	2x1	16			230	751.7210-DF