



Asfora

vypínače
a zásuvky



Katalóg 2021

www.se.com/sk

Life Is On

Schneider
Electric



Obsah

4	Prezentácia
10	Spínače
12	Ovládacie tlačidlá
14	Zásuvky
16	Anténne zásuvky
17	Dátové, telefónne a reproduktoré zásuvky
18	Otočné stmievače a USB nabíjačky
19	Krycie rámčeky, povrchové krabice, zaslepovacie kryty
20	Technické informácie - spínače a tlačidlá
21	Technické informácie - stmievače
22	Technické informácie - anténne zásuvky
24	Technické informácie - povrchové inštalačné krabice
25	Technické informácie - rozmery
26	Katalógové čísla - index

Asfora robí život jednoduchší

Vďaka modernému a elegantnému dizajnu ponúka rad Asfora všetko, čo potrebujete pre elektroinštaláciu v domácnosti. Vaši zákazníci ocenia jednoduchosť použitia a širokú škálu každodenných funkcií, ktoré poskytujú elektroinštalračné prístroje v rade Asfora. Asfora je navrhnutá tak, aby bola na dotyk príjemná rovnako ako na pohľad.



biela



krémová



aluminium



antracit

4

farby

2

prevedenia

50+

funkcií



až 6 rámček

Či už sa jedná o domácnosť alebo malú kanceláriu, viacnásobné rámčeky Asfora sú navrhnuté pre ľahkú manipuláciu počas inštalácie a čistý a zarovnaný vzhľad. V jednom rámčeku môžete kombinovať až 6 rôznych prístrojov.

Osvetlenie a komfort

Pomôžte svojim zákazníkom vyťažiť maximum zo svojich domácich interiérov s jedinečnou svetelnou atmosférou pre každú miestnosť a každú dennú dobu.



Spínač



Spínač s orientačnou kontrolkou a symbolom



Stmievateľ



Žalúziiový ovládač

Pripojenie

Pomôžte svojim zákazníkom mať digitálny svet stále po ruke. Môžu mať prístup ku všetkým médiám z jediného konektora alebo si vychutnať hudbu z jedného zdroja po celej domácnosti.



TV/R/SAT zásuvka



RJ45 dátové zásuvky



Reprodukčtorová zásuvka



USB nabíjacia zásuvka A + C

Bezpečnosť

Zásuvky s clonky chránia zákazníka pred dotykom kovových častí pod napätím. Výrobky v krytí IP44 sú často vyžadované v kúpeľni a kuchyni, aby boli chránené pred striekajúcou vodou.



Zásuvka IP44 s krytkou

Nové tesnenie IP44



Vo vlhkom prostredí alebo zlých podmienkach musia byť vypínače a zásuvky v súlade s prísnyimi regulačnými normami, ktoré stanovujú, že musia byť odolné proti striekajúcej vode.

Nové tesnenie IP44 pre spínače a zásuvky má výhodu, že je univerzálnejšie a odolnejšie, dokonca aj na nerovných stenách. Okrem toho je tesnenie v oblasti krabicových skrutiek flexibilné, takže skrutky nemusia byť pri inštalácii demontované. Vďaka tomu je inštalácia rýchla a jednoduchá.

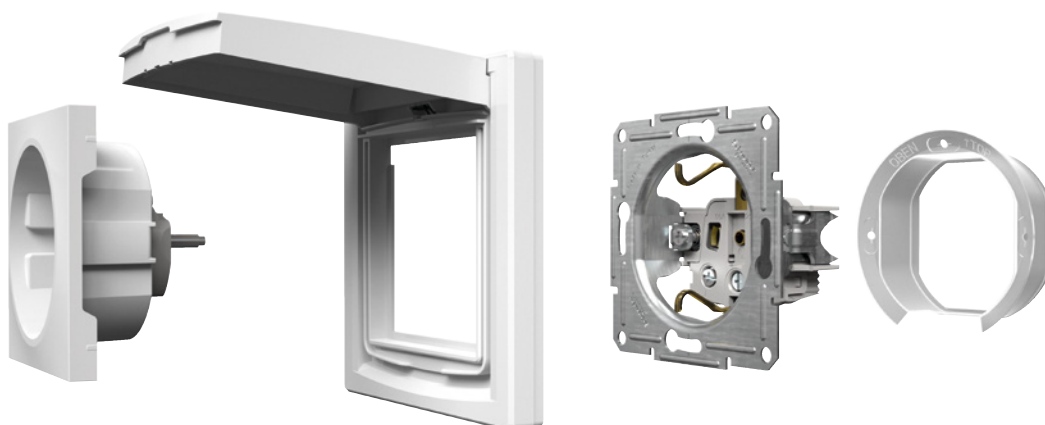

Rýchla a jednoduchá inštalácia



Univerzálny tvar vhodný aj pre nerovné steny

Flexibilné v oblasti skrutiek
Pre inštaláciu nie je potrebné odstraňovať skrutky

VYLEPŠENÉ!

Ochrana proti striekajúcej vode



Asfora tesnenie IP44

Nová vylepšená generácia mechanizmov spínačov a zásuviek

Nové mechanizmy - nové a vylepšené funkcie!

V spoločnosti Schneider Electric načúvame vašej spätnej väzbe a rozumieme tomu, čo potrebujete, aby ste svoju každodennú pracovnú rutinu uľahčili a zefektívnil. Preto sme nedávno vylepšili kvalitu a funkčnosť mechanizmov v rade Asfora. Aktualizovaný rad Asfora teraz obsahuje menšie, kompaktné mechanizmy, profilovaný spevnený montážny rámček, vylepšené vstupy pre vodiče a uvoľňovacie tlačidlá a širšie rozperky s vratnou pružinou, ktoré sú schované v ochrannéj plastovej vodiacej lište.

NOVINKA!

- + ľahké
- + rýchle
- + kompaktné

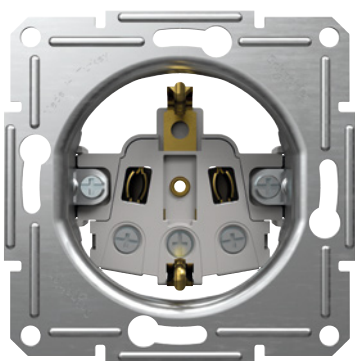

Mechanismus zásuvky

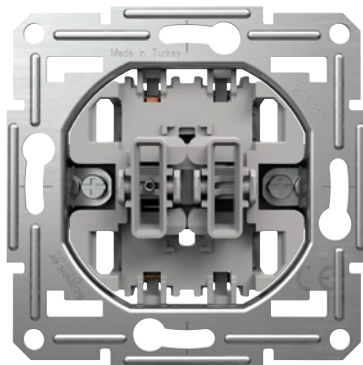

Mechanismus spínača



Video zapojenie zásuvky

Menšie, kompaktné mechanizmy

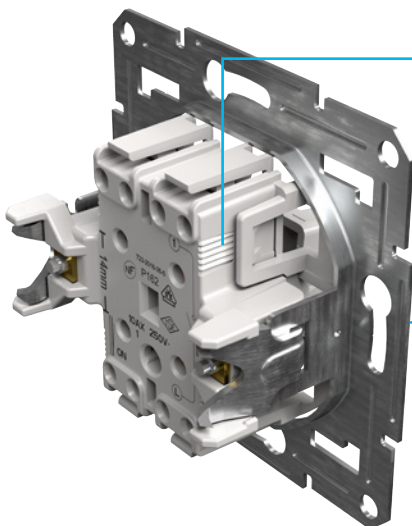

Menšie a kompaktné mechanizmy

poskytujú lepšie natočenie mechanizmu na skrutkách elektroinštalačnej krabice, viac priestoru pre zapojenie vodičov v krabici a lepšiu orientáciu vnútri škatule

Prepracovaný tvar mechanizmu

ponúka ďalšie úchyty pre lepšiu manipuláciu

Vylepšený montážny rámček a rozperky

Pre jednoduchú, rýchlu a bezpečnú inštaláciu

Vďaka ich prepracovanému mechanizmu sa rozperky roztvárajú rovno a hladko a zaisťujú dokonalé vyrovnanie so stenami počas montáže. Okrem toho zaisťujú, aby sa mechanizmus bezpečne upevnil v krabici. Pre upevňovanie pomocou rozperiek je nutné použiť špeciálne inštaláčne krabice.

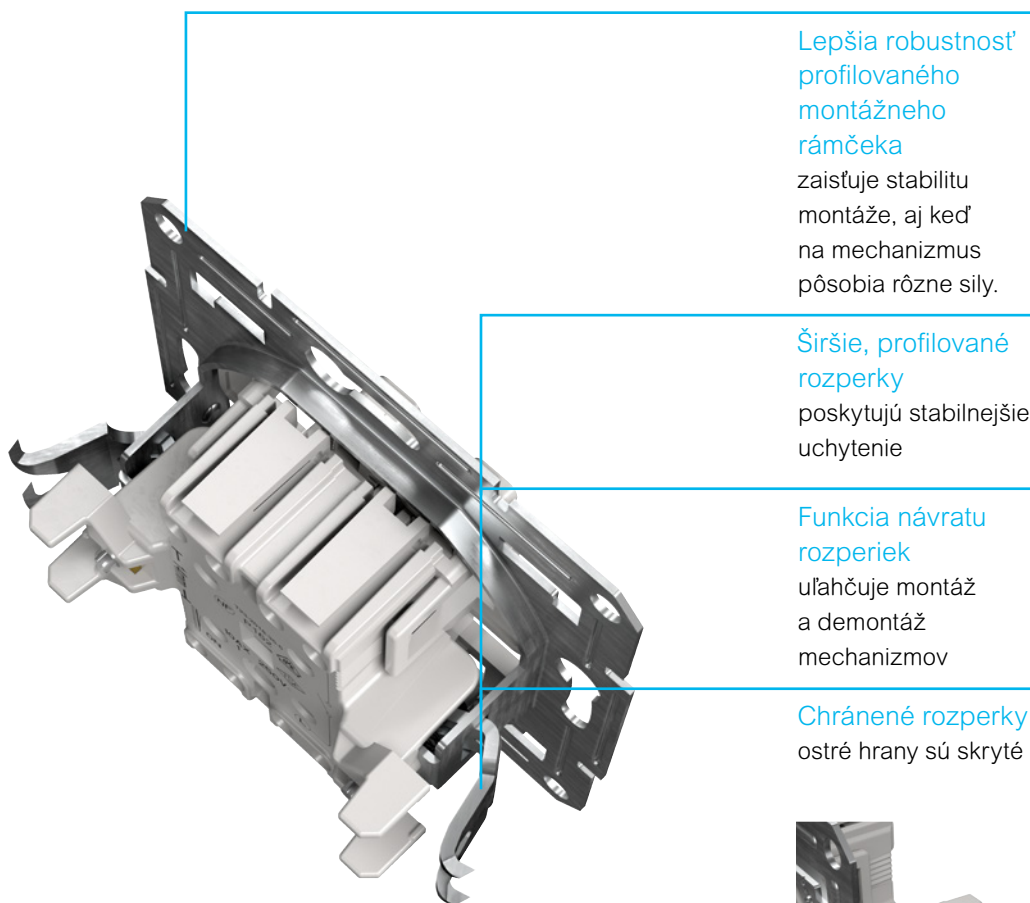

Lepšia robustnosť profilovaného montážneho rámčeka
zaisťuje stabilitu montáže, aj keď na mechanizmus pôsobia rôzne sily.

Širšie, profilované rozperky
poskytujú stabilnejšie uchytenie

Funkcia návratu rozperiek
uľahčuje montáž a demontáž mechanizmov

Chránené rozperky
ostré hrany sú skryté



Rozperky sú po stranách puzdra úplne zasunuté a pri inštalácii pomocou skrutiek neprekážajú.

Ďalšie technické výhody prístrojov

Naše nové inovatívne funkcie zmenia váš každodenný pracovný postup pri inštalácii.

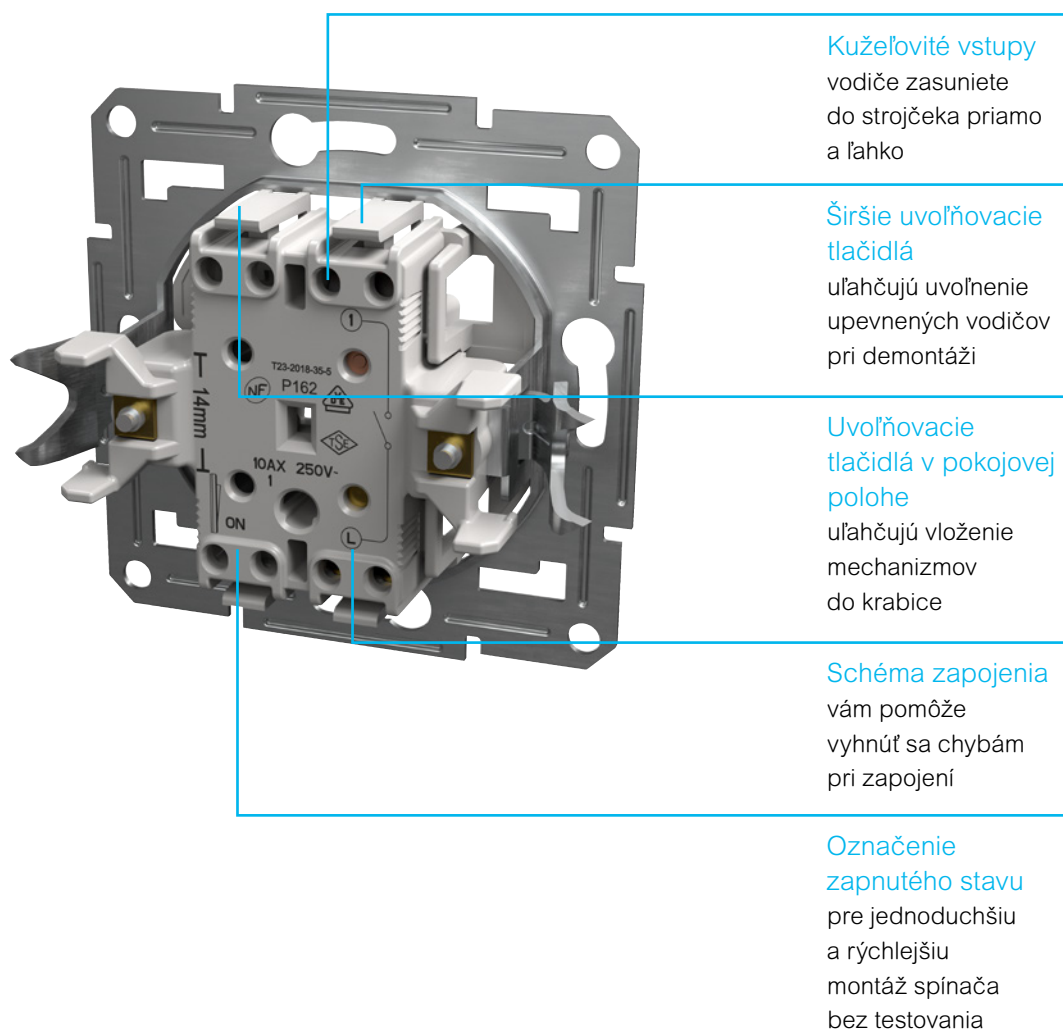

Spínače

Spínače 10 AX - 250 V AC

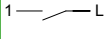
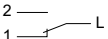
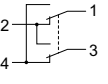
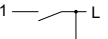
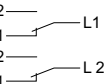
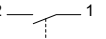
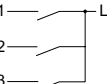
Jednopolový spínač r. 1	Striedavý prepínač r. 6	Křížový prepínač ř. 7	Prepínač sériový r. 5	Prepínač dvojité striedavý r. 6 + 6 (5b)	Dvojpólový spínač r. 2	Trojité spínač r. 1+1+1
						

Bezskrutkové svorky



Kompletný prístroj s rámčekom

<input type="checkbox"/> biela	EPH0100121	EPH0400121	EPH0500121	EPH0300121	EPH0600121	EPH0200121	
<input type="checkbox"/> krémová	EPH0100123	EPH0400123	EPH0500123	EPH0300123	EPH0600123	EPH0200123	



Prístroj bez rámčeka

<input type="checkbox"/> antracit	EPH0100171	EPH0400171	EPH0500171	EPH0300171	EPH0600171	EPH0200171	
<input type="checkbox"/> aluminium	EPH0100161	EPH0400161	EPH0500161	EPH0300161	EPH0600161	EPH0200161	



Skrutkové svorky



Kompletný prístroj s rámčekom

<input type="checkbox"/> biela	EPH0100321	EPH0400321	EPH0500321	EPH0300321	EPH0600321	EPH0200321	EPH2100121
<input type="checkbox"/> krémová	EPH0100323	EPH0400323	EPH0500323	EPH0300323	EPH0600323	EPH0200323	EPH2100123

Spínače v krytí IP44 10 AX - 250 V AC

Jednopolový spínač r. 1	Striedavý prepínač r. 6
	

Bezskrutkové svorky



Kompletný prístroj s rámčekom

<input type="checkbox"/> biela	EPH0100221	EPH0400421
<input type="checkbox"/> krémová	EPH0100223	EPH0400423
<input type="checkbox"/> antracit	EPH0100271	EPH0400471
<input type="checkbox"/> aluminium	EPH0100261	EPH0400461



Charakteristika

- Maximálna záťaž pre zdroje s vlastným predradníkom (LED, kompaktné žiarivky, atď.):
10 AX - 250 V AC spínače: 100 W
16 AX - 250 V AC spínače: 200 W

Spínače

Spínače s orient. kontrolkou 10 AX - 250 V AC

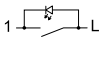
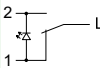
	Jednopolový spínač r. 1	Striedavý prepínač r. 6
		

Bezskrutkové svorky



Kompletný prístroj s rámčekom

<input type="checkbox"/> biela	EPH1400121	EPH1500121
<input type="checkbox"/> krémová	EPH1400123	EPH1500123



Prístroj bez rámčeka

<input checked="" type="checkbox"/> antracit	EPH1400171	EPH1500171
<input type="checkbox"/> aluminium	EPH1400161	EPH1500161

Skrutkové svorky



Kompletný prístroj s rámčekom

<input type="checkbox"/> biela	EPH1400321	EPH1500321
<input type="checkbox"/> krémová	EPH1400323	EPH1500323

Spínače s orient. kontrol. 16 AX - 250 V AC

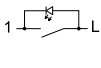
	Jednopolový spínač r. 1
	

Skrutkové svorky



Kompletný prístroj s rámčekom

<input type="checkbox"/> biela	EPH1430321
<input type="checkbox"/> krémová	EPH1430323



Prístroj bez rámčeka

<input checked="" type="checkbox"/> antracit	EPH1430371
<input type="checkbox"/> aluminium	EPH1430361

Žalúziiový spínač 10 A - 250 V AC

	Žalúziiový spínač
	

Bezskrutkové svorky



Kompletný prístroj s rámčekom

<input type="checkbox"/> biela	EPH1300521
<input type="checkbox"/> krémová	EPH1300523



Prístroj bez rámčeka

<input checked="" type="checkbox"/> antracit	EPH1300571
<input type="checkbox"/> aluminium	EPH1300561

Spínač pre hotelové karty 10 A - 250 V AC

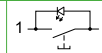
Bezskrutkové svorky



Kompletný prístroj s rámčekom

<input type="checkbox"/> biela	EPH6200121
<input type="checkbox"/> krémová	EPH6200123



Prístroj bez rámčeka

<input checked="" type="checkbox"/> antracit	EPH6200171
<input type="checkbox"/> aluminium	EPH6200161

Charakteristika

- Maximálna záťaž pre zdroje s vlastným predradníkom (LED, kompaktné žiarivky, atď.):
10 AX - 250 V AC spínače: 100 W
16 AX - 250 V AC spínače: 200 W

Ovládacie tlačidlá

Ovládacie tlačidlá 10 A - 250 V AC

	Jednoduché Tlačidlo 1/0	Tlačidlo 1/0 so symbolom zvončeka	Tlačidlo 1/0 so symbolom svetla	Dvojité Dvojité tlačidlo 1/0+1/0

Bezskrútkové svorky

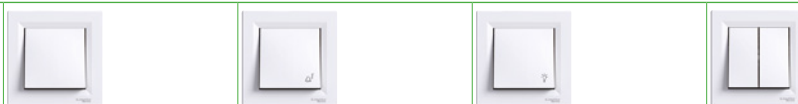

Kompletný prístroj s rámčekom

<input type="checkbox"/> biela	EPH0700121	EPH0800121	EPH0900121	EPH1100121
<input type="checkbox"/> krémová	EPH0700123	EPH0800123	EPH0900123	EPH1100123

Prístroj bez rámčeka

<input type="checkbox"/> antracit	EPH0700171	EPH0800171	EPH0900171	EPH1100171
<input type="checkbox"/> aluminium	EPH0700161	EPH0800161	EPH0900161	EPH1100161

Skrútkové svorky

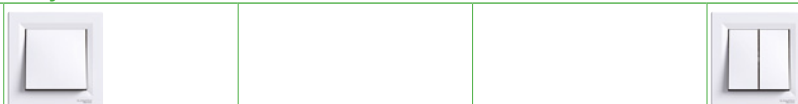

Kompletný prístroj s rámčekom

<input type="checkbox"/> biela	EPH0800321			EPH1100321
<input type="checkbox"/> krémová	EPH0800323			EPH1100323

Ovládacie tlačidlá

Ovládacie tlačidlá s orientačnou kontrolkou 10 A - 250 V AC

Tlačidlo 1/0	Tlačidlo 1/0 so symbolom zvončeka	Tlačidlo 1/0 so symbolom svetla	Tlačidlo 1/0 so symbolom schodov

Bezskrútkové svorky



Kompletný prístroj s rámčekom

<input type="checkbox"/> biela	EPH1600121	EPH1700121	EPH1800121	EPH1900121
<input type="checkbox"/> krémová	EPH1600123	EPH1700123	EPH1800123	EPH1900123



Prístroj bez rámčeka

<input checked="" type="checkbox"/> antracit	EPH1600171	EPH1700171	EPH1800171	EPH1900171
<input type="checkbox"/> aluminium	EPH1600161	EPH1700161	EPH1800161	EPH1900161

Skrútkové svorky



Kompletný prístroj s rámčekom

<input type="checkbox"/> biela	EPH1600321	EPH1700321		EPH1900321
<input type="checkbox"/> krémová	EPH1600323	EPH1700323		EPH1900323

Tlačidlo pre ovládanie žalúzií 10 A - 250 V AC

Žalúziové tlačidlo

Bezskrútkové svorky



Kompletný prístroj s rámčekom

<input type="checkbox"/> biela	EPH1300121
<input type="checkbox"/> krémová	EPH1300123



Prístroj bez rámčeka

<input checked="" type="checkbox"/> antracit	EPH1300171
<input type="checkbox"/> aluminium	EPH1300161

Skrútkové svorky



Kompletný prístroj s rámčekom

<input type="checkbox"/> biela	EPH1300321
<input type="checkbox"/> krémová	EPH1300323

Ovládacie tlačidlá - 12 V AC s orientačnou kontrolkou a s popisovacím poľom

Tlačidlo 1/0So

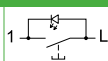

Bezskrútkové svorky



Kompletný prístroj s rámčekom

<input type="checkbox"/> biela	EPH1601521
<input type="checkbox"/> krémová	EPH1601523

Zásuvky

Zásuvky - 2P+E (s uzemňovacím kolíkom) 16 A - 250 V AC

	Jednonásobná zásuvka	Jednonásobná zásuvka s clonkami	Jednonásobná zásuvka s clonkami a krytom IP44	Jednonásobná zásuvka s clonkami a krytom IP44 [*]	Jednonásobná zásuvka s červenou centrálnou doskou	Dvojnásobná CZ, SK štandard [*]
Skrutkové svorky						
						
Kompletný prístroj s rámčekom						
<input type="checkbox"/> biela	EPH2800121	EPH2800221	EPH2800621	EPH2800321 [*]	EPH2800421	EPH9800121 [*]
<input type="checkbox"/> krémová	EPH2800123	EPH2800223	EPH2800623	EPH2800323 [*]	EPH2800423	EPH9800123 [*]
Kompletný prístroj s rámčekom a s prepäťovou ochranou						
<input type="checkbox"/> biela		EPH2800221P			EPH2800421P	EPH9800121P [*]
						
Prístroj bez rámčeka						
<input checked="" type="checkbox"/> antracit	EPH2800171	EPH2800271	EPH2800671			
<input type="checkbox"/> aluminium	EPH2800161	EPH2800261	EPH2800661			

[*] Nie je kompatibilný so systémom krycích rámčekov (možno použiť len ako kompletný jednonásobný prístroj).

Zásuvky

Zásuvky - 2P+E (bočné kontakty SCHUKO) 16 A - 250 V AC

	Jednonásobná zásuvka	Jednonásobná zásuvka s clonkami	Jednonásobná zásuvka s clonkami a krytom	Jednonásobná zásuvka s clonkami a krytom [*]	Jednonásobná zásuvka s červenou centrálnou doskou	Dvojnásobná DE štandard [*]
--	----------------------	---------------------------------	--	--	---	-----------------------------

Skrutkové svorky



Kompletný prístroj s rámečkom

<input type="checkbox"/> biela	EPH2900121	EPH2900221	EPH3100121	EPH3100321 [*]	EPH2900521	EPH9900121 [*]
<input type="checkbox"/> krémová	EPH2900123	EPH2900223	EPH3100123	EPH3100323 [*]	EPH2900523	EPH9900123 [*]

Prístroj bez rámečka

<input checked="" type="checkbox"/> antracit	EPH2900171	EPH2900271	EPH3100171			
<input type="checkbox"/> aluminium	EPH2900161	EPH2900261	EPH3100161			

[*] Nie je kompatibilný so systémom krycích rámečkov (možno použiť len ako kompletný jednonásobný prístroj).

Káblové vývodky

Skrutkové svorky



Kompletný prístroj s rámečkom

<input type="checkbox"/> biela	EPH5500121
<input type="checkbox"/> krémová	EPH5500123

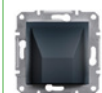

Prístroj bez rámečka

<input checked="" type="checkbox"/> antracit	EPH5500171
<input type="checkbox"/> aluminium	EPH5500161

Anténne zásuvky

Anténne zásuvky

Typ konektora	Koncové (1 dB)					
	TV	TV-R	TV-SAT	TV-R-SAT	TV-SAT-SAT	SAT
	IEC samec	IEC samec + samica	IEC samec + F konektor	IEC samec + samica + F konektor	IEC samec + F konektor + F konektor	F konektor

Kompletný prístroj s rámčekom						
<input type="checkbox"/> biela	EPH3200121	EPH3300121	EPH3400121	EPH3500121	EPH3600121	EPH3700121
<input type="checkbox"/> krémová	EPH3200123	EPH3300123	EPH3400123	EPH3500123	EPH3600123	EPH3700123

Prístroj bez rámčeka						
<input type="checkbox"/> antracit	EPH3200171	EPH3300171	EPH3400171	EPH3500171	EPH3600171	EPH3700171
<input type="checkbox"/> aluminium	EPH3200161	EPH3300161	EPH3400161	EPH3500161	EPH3600161	EPH3700161

Typ konektora	Priebežné (4 dB)					
	TV	TV-R	TV-SAT	TV-R-SAT		SAT

Kompletný prístroj s rámčekom						
<input type="checkbox"/> biela	EPH3200221	EPH3300221	EPH3400221	EPH3500221		EPH3700221
<input type="checkbox"/> krémová	EPH3200223	EPH3300223	EPH3400223	EPH3500223		EPH3700223

Prístroj bez rámčeka						
<input type="checkbox"/> antracit	EPH3200271	EPH3300271	EPH3400271	EPH3500271		EPH3700271
<input type="checkbox"/> aluminium	EPH3200261	EPH3300261	EPH3400261	EPH3500261		EPH3700261

Typ konektora	Priebežné (8 dB)			
	TV	TV-R	TV-SAT	TV-R-SAT

Kompletný prístroj s rámčekom				
<input type="checkbox"/> biela	EPH3200321	EPH3300321	EPH3400321	EPH3500321
<input type="checkbox"/> krémová	EPH3200323	EPH3300323	EPH3400323	EPH3500323

Prístroj bez rámčeka				
<input type="checkbox"/> antracit	EPH3200371	EPH3300371	EPH3400371	EPH3500371
<input type="checkbox"/> aluminium	EPH3200361	EPH3300361	EPH3400361	EPH3500361







Individuálne (1 dB)	
Typ konektora	TV-SAT





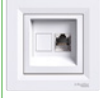

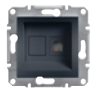
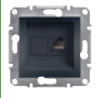



Kompletný s rámčekom	
<input type="checkbox"/> biela	EPH3400421
<input type="checkbox"/> krémová	EPH3400423

Prístroj bez rámčeka	
<input type="checkbox"/> antracit	EPH3400471
<input type="checkbox"/> aluminium	EPH3400461

Dátové, telefónne a reproduktorové zásuvky

Dátové a telefónne zásuvky

	Jednonásobné RJ11			
		RJ45 Kat.5e UTP	RJ45 Kat.5e STP	RJ45 Kat.6 UTP
Svorky	Skrutkové	IDC	IDC	IDC
				
Kompletný prístroj s rámčekom				
<input type="checkbox"/> biela	EPH4100121	EPH4300121	EPH5000121	EPH4700121
<input type="checkbox"/> krémová	EPH4100123	EPH4300123	EPH5000123	EPH4700123
				
Prístroj bez rámčeka				
<input type="checkbox"/> antracit	EPH4100171	EPH4300171	EPH5000171	EPH4700171
<input type="checkbox"/> aluminium	EPH4100161	EPH4300161	EPH5000161	EPH4700161

	Dvojnásobné RJ11					
		RJ45 Kat.5e UTP		RJ45 Kat.6 UTP	RJ45 + RJ11 Kat.6 UTP	RJ45 + RJ12 Kat.5e UTP
Svorky	Skrutkové	IDC		IDC	IDC - skrutkové	IDC
						
Kompletný prístroj s rámčekom						
<input type="checkbox"/> biela	EPH4200121	EPH4400121		EPH4800121	EPH5200121	EPH4900121
<input type="checkbox"/> krémová	EPH4200123	EPH4400123		EPH4800123	EPH5200123	EPH4900123
						
Prístroj bez rámčeka						
<input type="checkbox"/> antracit	EPH4200171	EPH4400171		EPH4800171	EPH5200171	EPH4900171
<input type="checkbox"/> aluminium	EPH4200161	EPH4400161		EPH4800161	EPH5200161	EPH4900161

Reproduktorové zásuvky

Dvojité reproduktorové zásuvky

Bezskrutkové svorky



Kompletný prístroj s rámčekom

<input type="checkbox"/> biela	EPH5700121
<input type="checkbox"/> krémová	EPH5700123









Prístroj bez rámčeka

<input type="checkbox"/> antracit	EPH5700171
<input type="checkbox"/> aluminium	EPH5700161

Otočné stmievače a USB nabíjačky

Otočné stmievače - 230 V AC

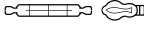
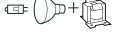
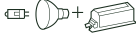
	600 VA, striedavý r.6	600 VA, striedavý r.6 s orientačnou kontrolkou (1)	315 VA, striedavý r.6
	Skrutkové svorky (pillar type)		
			
	Kompletný prístroj s rámčekom		
<input type="checkbox"/> biela	EPH6400121	EPH6500121	EPH6600121
<input type="checkbox"/> krémová	EPH6400123	EPH6500123	EPH6600123
			
	Prístroj bez rámčeka		
<input type="checkbox"/> antracit	EPH6400171	EPH6500171	EPH6600171
<input type="checkbox"/> aluminium	EPH6400161	EPH6500161	EPH6600161
Charakteristiky			
Skratová ochrana	Poistka F6, 3 AH - 250 V		Electronické
Záťaže			
230 V AC žiarovky 	40-600 W	40-600 W	20-315 W
230 V AC halogénové lampy 	40-600 W	40-600 W	20-315 W
Nízkonapäťové lampy s feromagnetickým transformátorom 	40-600 VA	40-600 VA	-
Nízkonapäťové lampy s elektronickým transformátorom 	-	-	20-315 VA







(1) Orientačná kontrolka je umiestnená pod otočným tlačidlom.

USB nabíjačky



	Dvojitá USB nabíjačka typu A, 2,1 A alebo 2 x 1,05 A	Dvojitá USB nabíjačka typu A + C, 2,4 A alebo 2 x 1,2 A
		
	Kompletný prístroj s rámčekom	
<input type="checkbox"/> biela	EPH2700221	EPH2700321
<input type="checkbox"/> krémová	EPH2700223	EPH2700323
		
	Prístroj bez rámčeka	
<input type="checkbox"/> antracit	EPH2700271	EPH2700371
<input type="checkbox"/> aluminium	EPH2700261	EPH2700361

Krycie rámčeky, povrchové krabice, zaslepovacie kryty

Krycie rámčeky

	Jednonásobné	Dvojnásobné	Trojnásobné	Štvornásobné	Pätinasobné	Šesťnásobné
Horizontálne						
						
						
						
<input type="checkbox"/> biela	EPH5800121	EPH5800221	EPH5800321	EPH5800421	EPH5800521	EPH5800621
<input type="checkbox"/> krémová	EPH5800123	EPH5800223	EPH5800323	EPH5800423	EPH5800523	EPH5800623
<input type="checkbox"/> antracit	EPH5800171	EPH5800271	EPH5800371	EPH5800471	EPH5800571	EPH5800671
<input type="checkbox"/> aluminium	EPH5800161	EPH5800261	EPH5800361	EPH5800461	EPH5800561	EPH5800661

Vertikálne

	Dvojnásobné	Trojnásobné
		
<input type="checkbox"/> biela	EPH5810221	EPH5810321
<input type="checkbox"/> krémová	EPH5810223	EPH5810323
<input type="checkbox"/> antracit	EPH5810271	EPH5810371
<input type="checkbox"/> aluminium	EPH5810261	EPH5810361

Povrchové inštalčné krabice

	Jednonásobné	Viacnásobné rozširujúce
Bezskrútkové a skrútkové svorky		
		
<input type="checkbox"/> biela	EPH6100121	EPH6100221
<input type="checkbox"/> krémová	EPH6100123	EPH6100223
<input type="checkbox"/> antracit	EPH6100171	EPH6100271
<input type="checkbox"/> aluminium	EPH6100161	EPH6100261

Jednonásobná krabica obsahuje odnímateľné bočnice.

Zaslepovacie kryty

	
Kompletný prístroj s rámčekom	
<input type="checkbox"/> biela	EPH5600121
<input type="checkbox"/> krémová	EPH5600123
	
Prístroj bez rámčeka	
<input type="checkbox"/> antracit	EPH5600171
<input type="checkbox"/> aluminium	EPH5600161

Technické informácie

Spínače a tlačidlá

Príklady zapojenia

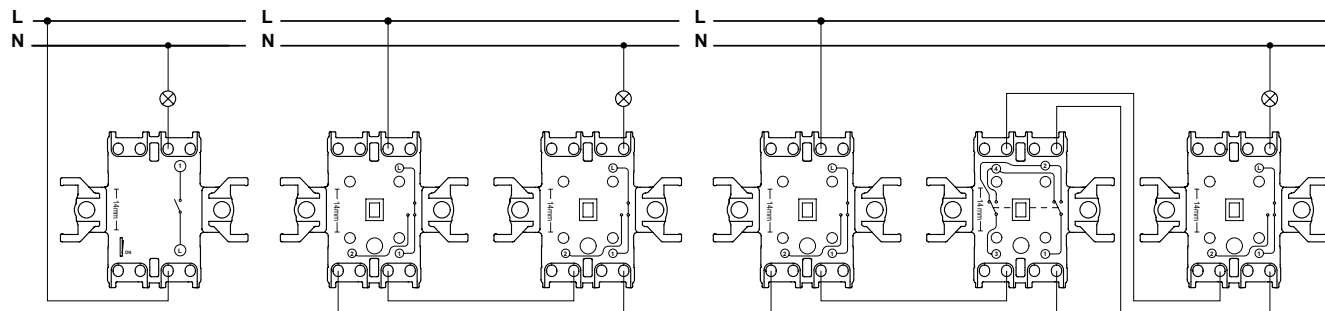

Jednopolový spínač

2 striedavé prepínače

2 striedavé prepínače + 1 križový prepínač

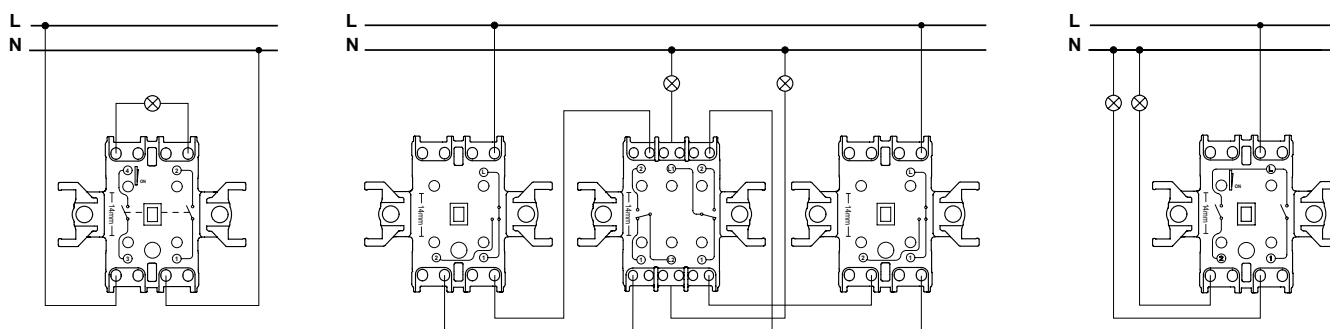

Dvojpolový spínač

2 striedavé prepínače + 1 dvojitý striedavý prepínač spínajúci dve rôzne záťaže

Sériový prepínač

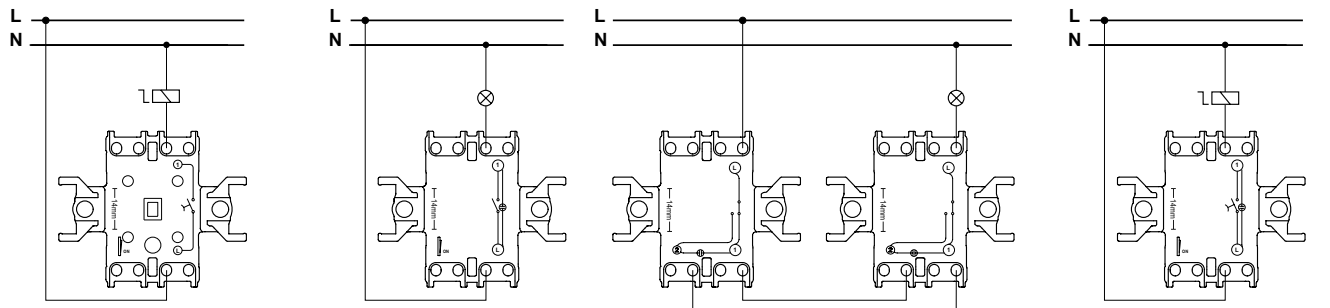

Tlačidlo

Jednopolový spínač s orientačnou kontrolkou

Striedavé prepínače s orientačnou kontrolkou

Tlačidlový ovládač s orientačnou kontrolkou

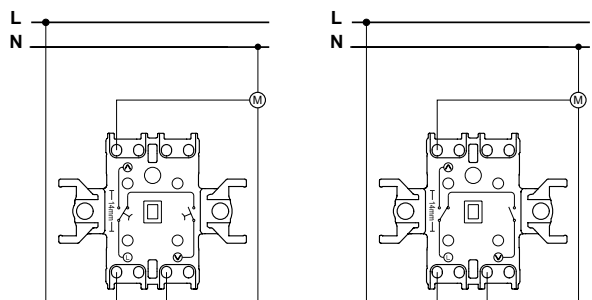

Žalúziový tlačidlový ovládač

Žalúziový spínač

Technické informácie

Stmievачe

Otočný elektronický stmievач

Montáž

Pokiaľ prístroj nie je zapojený v štandardnej zápustnej krabici, musíte znížiť maximálne zafaženie, aby sa zlepšil odvod tepla.

Redukcia zafazže o	Montáž v dutých priechkach ⁽¹⁾	Niekoľko inštalovaných stmievачov v kombinácii ⁽¹⁾	V jednonásobnej alebo dvojnásobnej povrchovej inštaláčnej krabici	V trojnásobnej povrchovej inštaláčnej krabici
25 %	■	■		
30 %			■	
50 %				■

(1) Ak platí niekoľko faktorov, redukciu zafazže sčítajte.

Zapojenie

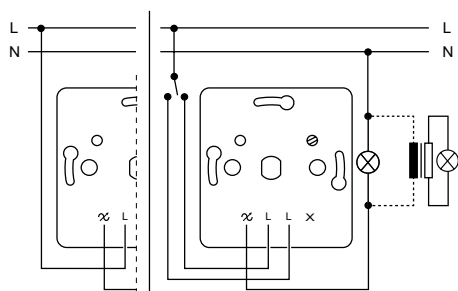

Stmievачe – EPH64001xx - EPH65001xx

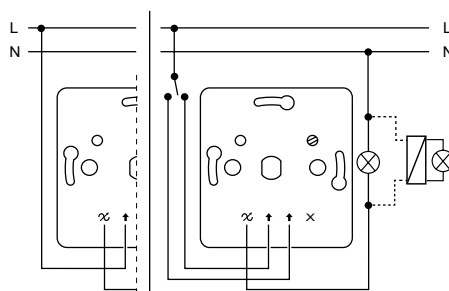

Stmievачe – EPH66001xx

Príklad substitúcií

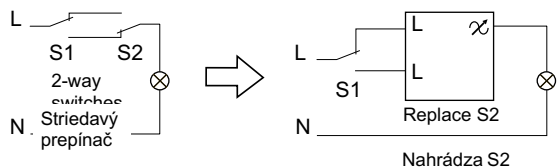
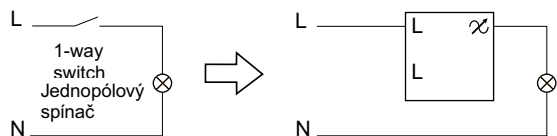

Technické informácie

Anténne zásuvky

Typ	TV			TV-R			
	Koncové 1 dB	Priebežné 4 dB	Priebežné 8 dB	Koncové 1 dB	Priebežné 4 dB	Priebežné 8 dB	
	EPH32001xx EPH32701xx	EPH32002xx	EPH32003xx EPH32703xx	EPH33001xx EPH33007xx	EPH33002xx	EPH33003xx	
Útlm	dB	1	4	8	1	4	8
Prevádzková frekvencia	SAT	MHz	-	-	-	-	-
	TV/VHF		5-862	5-862	5-862	118-470	118-470
	TV/UHF		5-862	5-862	5-862	470-830	470-830
	R		-	-	-	10-108	10-108
Útlm pri priebehu	SAT	dB	-	-	-	-	-
	TV/VHF		1	4	8	1,5	3,7
	TV/UHF		1	4	8	2,8	4,6
	R		-	-	-	11,1	9,3
Výstupný útlm	dB	1	4	8	0,5	0,5	0,5
DC prúd		-	-	-	-	-	-
Zásuviek na linku		-	-	-	1	4	4

Typ	TV-SAT				TV-R-SAT		
	Koncové 1 dB	Priebežné 4 dB	Priebežné 8 dB	Individuálne 1 dB	Koncové 1 dB	Priebežné 4 dB	Priebežné 8 dB
	EPH34001xx EPH34701xx	EPH34002xx	EPH34003xx EPH34703xx	EPH34004xx	EPH35001xx	EPH35002xx	EPH35003xx
Útlm	dB	1	4	8	1	4	8
Prevádzková frekvencia	SAT	MHz	950-2400	950-2400	950-2400	950-2400	950-2400
	TV/VHF		118-470	118-470	118-470	118-470	118-470
	TV/UHF		470-830	470-830	470-830	470-830	470-830
	R		-	-	-	10-108	10-108
Útlm pri priebehu	SAT	dB	13	12,1	10,3	13	4,1
	TV/VHF		2,2	4,5	10,8	2,2	1,5
	TV/UHF		1	4,8	12,3	1	2,7
	R		-	-	-	14,8	16,8
Výstupný útlm	dB	-	0,5	0,5	-	-	0,5
DC prúd		v SAT zásuvke	v SAT zásuvke	v SAT zásuvke	v SAT zásuvke	v SAT zásuvke	v SAT zásuvke
Zásuviek na linku		1	4	4	1	4	4

Typ	TV-SAT-SAT		SAT	
	Koncové 1 dB	Koncové 1 dB	Priebežné 4 dB	
	EPH36001xx EPH36701xx	EPH37001xx EPH37701xx	EPH37002xx	
Útlm	dB	1	1	4
Prevádzková frekvencia	SAT	MHz	950-2400	950-2400
	TV/VHF		118-470	118-470
	TV/UHF		470-830	470-830
	R		-	10-108
Útlm pri priebehu	SAT	dB	13	4,1
	TV/VHF		2,2	1,5
	TV/UHF		1	2,7
	R		-	14,8
Výstupný útlm	dB	-	-	0,5
DC prúd		v SAT zásuvke	v SAT zásuvke	v SAT zásuvke
Zásuviek na linku		1	1	4

Iba jediná zásuvka „Koncová TV-R zásuvka“ môže byť použitá ako individuálna.
V lineárnej inštalácii možno ako koncovú použiť len káblovú zásuvku v „individuálnej TV / SAT zásuvke“.

Technické informácie

Anténne zásuvky

TV/R aplikácie

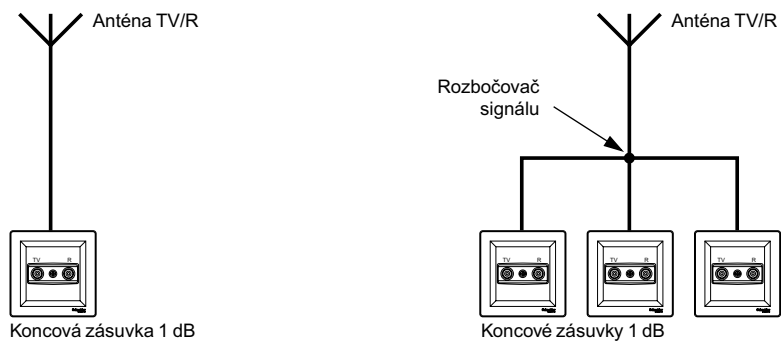

Lineárne inštalačné mechanizmy priebežné 4 dB, 8 dB a koncové 1 dB (vždy na konci)

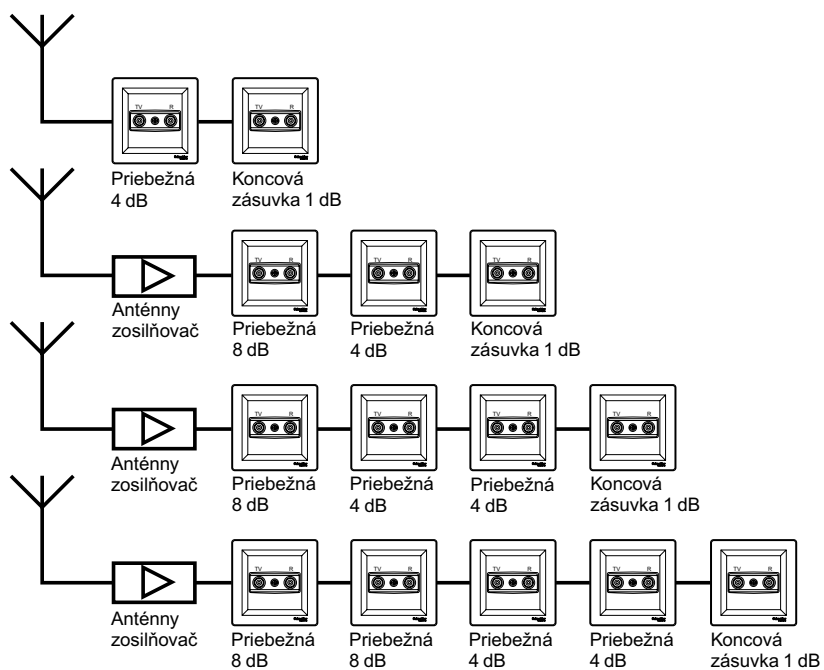

Technické informácie

Povrchové inštalačné krabice

Jednonásobná montáž

(EPH61001xx)

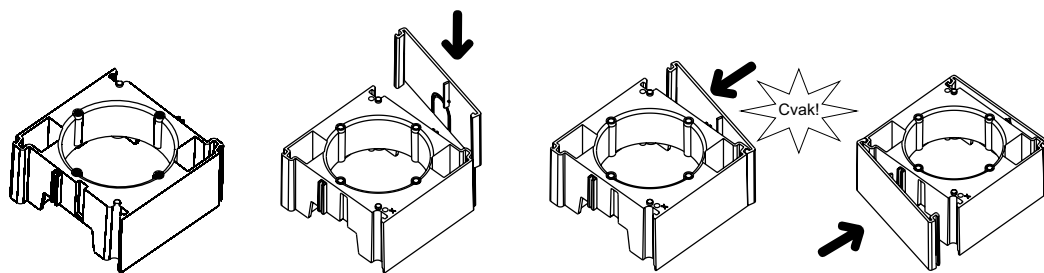

Viacnásobná montáž

(EPH61001xx + EPH61002xx)

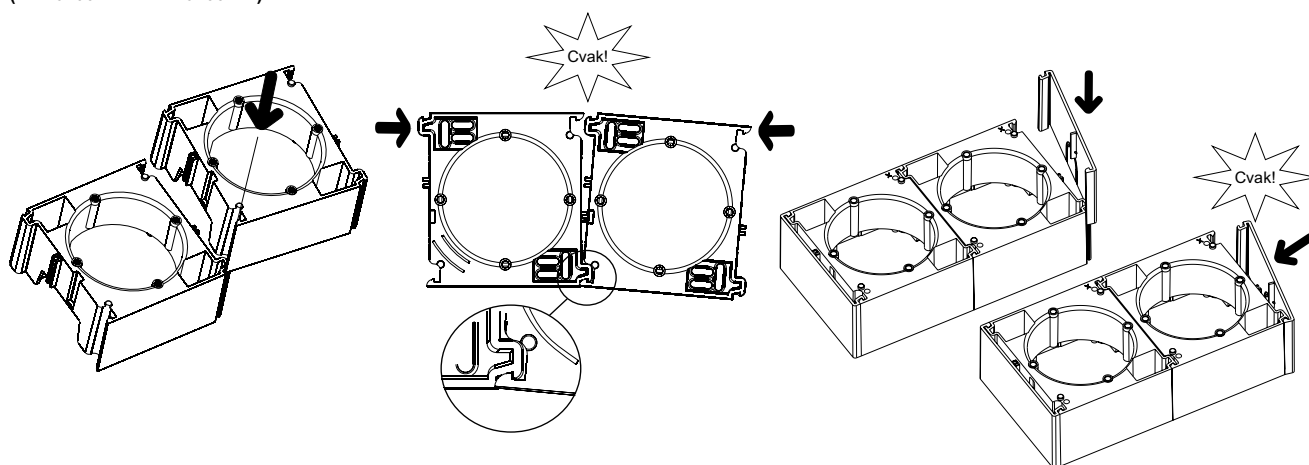

Montáž sa zásuvkami TV/R, TV/SAT, TV/R/SAT

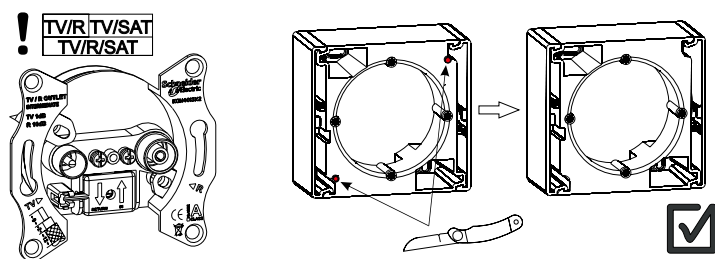

Technické informácie

Rozmery

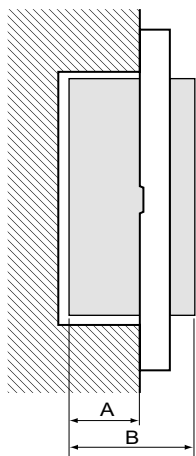

A: Hĺbka zapustenia
B: Hĺbka celková

Katalógové číslo	A (mm)	B (mm)	Katalógové číslo	A (mm)	B (mm)	Katalógové číslo	A (mm)	B (mm)	Katalógové číslo	A (mm)	B (mm)
EPH01001xx	28	43	EPH13001xx	28	43	EPH29005xx	32	42	EPH41001xx	29	38
EPH01002xx	28	43	EPH13003xx	28	43	EPH30001xx	32	42	EPH42001xx	29	38
EPH01003xx	28	43	EPH13005xx	28	43	EPH31001xx	32	47	EPH43001xx	27	36
EPH02001xx	28	43	EPH14001xx	28	43	EPH31003xx	32	42	EPH44001xx	27	36
EPH02003xx	28	43	EPH14003xx	28	43	EPH32001xx	28	38	EPH47001xx	27	36
EPH03001xx	28	43	EPH14303xx	28	43	EPH32002xx	28	38	EPH48001xx	27	36
EPH03003xx	28	43	EPH15001xx	28	43	EPH32003xx	28	38	EPH49001xx	27	36
EPH04001xx	28	43	EPH15003xx	28	43	EPH33001xx	28	38	EPH50001xx	39	48
EPH04003xx	28	43	EPH16001xx	28	43	EPH33002xx	28	38	EPH56001xx	26	35
EPH04004xx	28	43	EPH16003xx	28	43	EPH33003xx	28	38	EPH57001xx	26	43
EPH05001xx	28	43	EPH17001xx	28	43	EPH34001xx	29	42	EPH62001xx	29	52
EPH05003xx	28	43	EPH17003xx	28	43	EPH34002xx	29	42	EPH63001xx	29	52
EPH06001xx	28	43	EPH18001xx	28	43	EPH34003xx	29	42	EPH64001xx	29	49
EPH06003xx	28	43	EPH19003xx	28	43	EPH34004xx	29	42	EPH65001xx	29	49
EPH07001xx	28	43	EPH28001xx	32	42	EPH35001xx	29	42	EPH66001xx	29	49
EPH08001xx	28	43	EPH28002xx	32	42	EPH35002xx	29	42	EPH97001xx	23	46
EPH08003xx	28	43	EPH28003xx	32	48	EPH35003xx	29	42	EPH97002xx	23	46
EPH09001xx	28	43	EPH28004xx	32	42	EPH36001xx	29	42	EPH98001xx	23	46
EPH11001xx	28	43	EPH29001xx	32	42	EPH37001xx	29	42	EPH98002xx	23	46
EPH11003xx	28	43	EPH29002xx	32	42	EPH37002xx	29	42	EPH99001xx	23	46

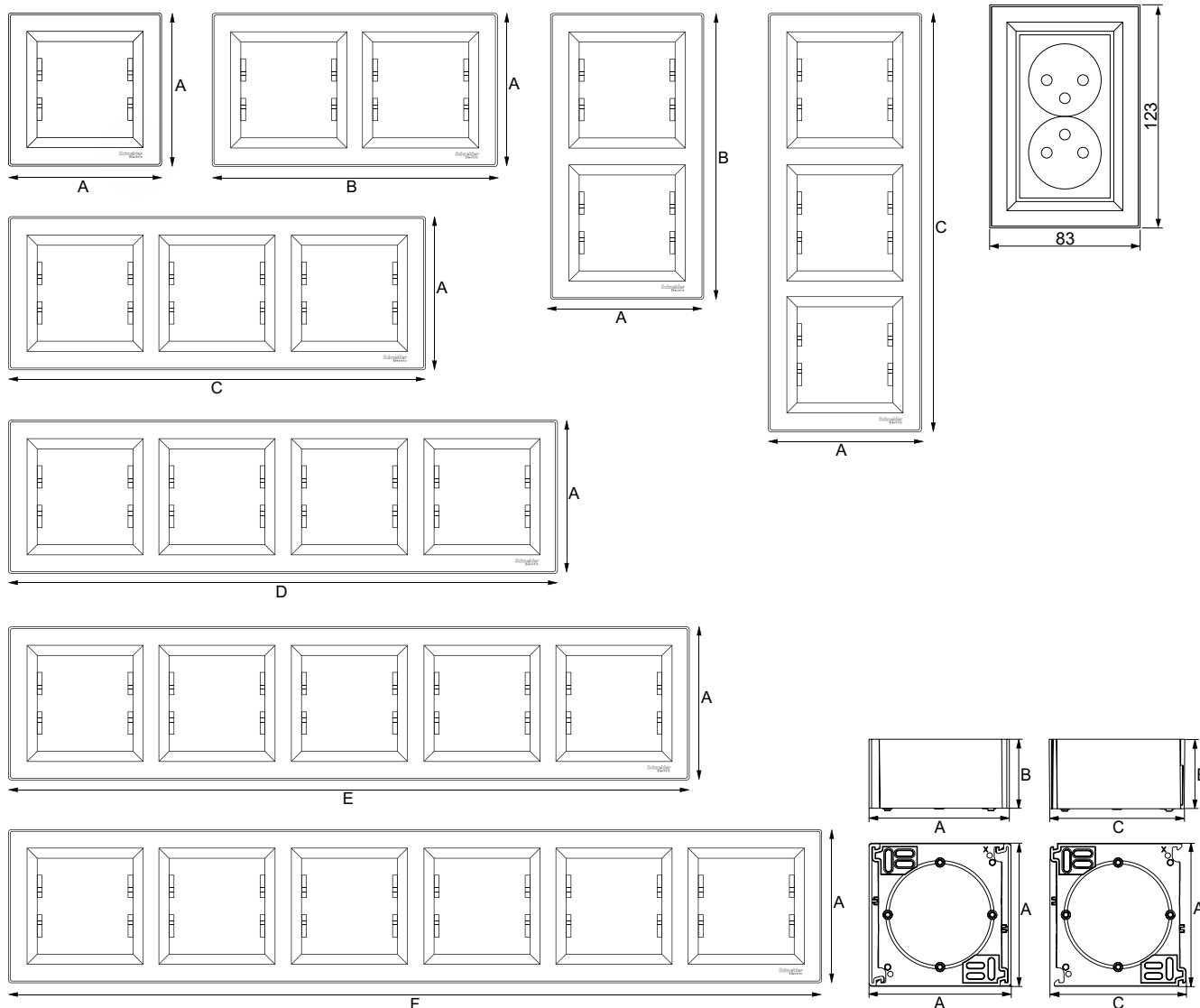

Horizontálne a vertikálne rámčeky (mm)

Jednonásobné		Dvojnásobné		Trojnásobné		Štvornásobné		Pätnásobné		Šestnásobné	
A	B	C	D	E	F	A	B	A	B	A	B
83	154	225	296	367	439						

Povrchové inštaláčne krabice (mm)

Jednonásobné		Rozširujúce		
A	B	A	B	C
82	40	82	40	78

Katalógové čísla

Index

Kat. č.	Str.	Kat. č.	Str.	Kat. č.	Str.	Kat. č.	Str.	Kat. č.	Str.
EPH01001xx	25	EPH36001xx	22, 25	EPH0500171	10	EPH1600123	13	EPH3100171	15
EPH01002xx	25	EPH36701xx	22	EPH0500321	10	EPH1600161	13	EPH3100321	15
EPH01003xx	25	EPH37001xx	22, 25	EPH0500323	10	EPH1600171	13	EPH3100323	15
EPH02001xx	25	EPH37002xx	22, 25	EPH0600121	10	EPH1600321	13	EPH3200121	16
EPH02003xx	25	EPH37701xx	22	EPH0600123	10	EPH1600323	13	EPH3200123	16
EPH03001xx	25	EPH41001xx	25	EPH0600161	10	EPH1601521	13	EPH3200161	16
EPH03003xx	25	EPH42001xx	25	EPH0600171	10	EPH1601523	13	EPH3200171	16
EPH04001xx	25	EPH43001xx	25	EPH0600321	10	EPH1700121	13	EPH3200221	16
EPH04003xx	25	EPH44001xx	25	EPH0600323	10	EPH1700123	13	EPH3200223	16
EPH04004xx	25	EPH47001xx	25	EPH0700121	12	EPH1700161	13	EPH3200261	16
EPH05001xx	25	EPH48001xx	25	EPH0700123	12	EPH1700171	13	EPH3200271	16
EPH05003xx	25	EPH49001xx	25	EPH0700161	12	EPH1700321	13	EPH3200321	16
EPH06001xx	25	EPH50001xx	25	EPH0700171	12	EPH1700323	13	EPH3200323	16
EPH06003xx	25	EPH56001xx	25	EPH0800121	12	EPH1800121	13	EPH3200361	16
EPH07001xx	25	EPH57001xx	25	EPH0800123	12	EPH1800123	13	EPH3200371	16
EPH08001xx	25	EPH61001xx	24	EPH0800161	12	EPH1800161	13	EPH3300121	16
EPH08003xx	25	EPH61002xx	24	EPH0800171	12	EPH1800171	13	EPH3300123	16
EPH09001xx	25	EPH62001xx	25	EPH0800321	12	EPH1900121	13	EPH3300161	16
EPH11001xx	25	EPH63001xx	25	EPH0800323	12	EPH1900123	13	EPH3300171	16
EPH11003xx	25	EPH64001xx	25	EPH0900121	12	EPH1900161	13	EPH3300221	16
EPH13001xx	25	EPH65001xx	25	EPH0900123	12	EPH1900171	13	EPH3300223	16
EPH13003xx	25	EPH66001xx	25	EPH0900161	12	EPH1900321	13	EPH3300261	16
EPH13005xx	25	EPH97001xx	25	EPH0900171	12	EPH1900323	13	EPH3300271	16
EPH14001xx	25	EPH97002xx	25	EPH1100121	12	EPH2100121	10	EPH3300321	16
EPH14003xx	25	EPH98001xx	25	EPH1100123	12	EPH2100123	10	EPH3300323	16
EPH14303xx	25	EPH98002xx	25	EPH1100161	12	EPH2700221	18	EPH3300361	16
EPH15001xx	25	EPH99001xx	25	EPH1100171	12	EPH2700223	18	EPH3300371	16
EPH15003xx	25	EPH0100121	10	EPH1100321	12	EPH2700261	18	EPH3400121	16
EPH16001xx	25	EPH0100123	10	EPH1100323	12	EPH2700271	18	EPH3400123	16
EPH16003xx	25	EPH0100161	10	EPH1300121	13	EPH2700321	18	EPH3400161	16
EPH17001xx	25	EPH0100171	10	EPH1300123	13	EPH2700323	18	EPH3400171	16
EPH17003xx	25	EPH0100221	10	EPH1300161	13	EPH2700361	18	EPH3400221	16
EPH18001xx	25	EPH0100223	10	EPH1300171	13	EPH2700371	18	EPH3400223	16
EPH19003xx	25	EPH0100261	10	EPH1300321	13	EPH2800121	14	EPH3400261	16
EPH28001xx	25	EPH0100271	10	EPH1300323	13	EPH2800123	14	EPH3400271	16
EPH28002xx	25	EPH0100321	10	EPH1300521	11	EPH2800161	14	EPH3400321	16
EPH28003xx	25	EPH0100323	10	EPH1300523	11	EPH2800171	14	EPH3400323	16
EPH28004xx	25	EPH0200121	10	EPH1300561	11	EPH2800221	14	EPH3400361	16
EPH29001xx	25	EPH0200123	10	EPH1300571	11	EPH2800223	14	EPH3400371	16
EPH29002xx	25	EPH0200161	10	EPH1370521	11	EPH2800261	14	EPH3400421	16
EPH29005xx	25	EPH0200171	10	EPH1370523	11	EPH2800271	14	EPH3400423	16
EPH30001xx	25	EPH0200321	10	EPH1400121	11	EPH2800321	14	EPH3400461	16
EPH31001xx	25	EPH0200323	10	EPH1400123	11	EPH2800323	14	EPH3400471	16
EPH31003xx	25	EPH0300121	10	EPH1400161	11	EPH2800421	14	EPH3500121	16
EPH32001xx	22, 25	EPH0300123	10	EPH1400171	11	EPH2800423	14	EPH3500123	16
EPH32002xx	22, 25	EPH0300161	10	EPH1400321	11	EPH2800621	14	EPH3500161	16
EPH32003xx	22, 25	EPH0300171	10	EPH1400323	11	EPH2800623	14	EPH3500171	16
EPH32701xx	22	EPH0300321	10	EPH1430321	11	EPH2800661	14	EPH3500221	16
EPH32703xx	22	EPH0300323	10	EPH1430323	11	EPH2800671	14	EPH3500223	16
EPH33001xx	22, 25	EPH0400121	10	EPH1430361	11	EPH2900121	15	EPH3500261	16
EPH33002xx	22, 25	EPH0400123	10	EPH1430371	11	EPH2900123	15	EPH3500271	16
EPH33003xx	22, 25	EPH0400161	10	EPH1470121	11	EPH2900161	15	EPH3500321	16
EPH33007xx	22	EPH0400171	10	EPH1470123	11	EPH2900171	15	EPH3500323	16
EPH34001xx	22, 25	EPH0400321	10	EPH1500121	11	EPH2900221	15	EPH3500361	16
EPH34002xx	22, 25	EPH0400323	10	EPH1500123	11	EPH2900223	15	EPH3500371	16
EPH34003xx	22, 25	EPH0400421	10	EPH1500161	11	EPH2900261	15	EPH3600121	16
EPH34004xx	22, 25	EPH0400423	10	EPH1500171	11	EPH2900271	15	EPH3600123	16
EPH34701xx	22	EPH0400461	10	EPH1500321	11	EPH2900521	15	EPH3600161	16
EPH34703xx	22	EPH0400471	10	EPH1500323	11	EPH2900523	15	EPH3600171	16
EPH35001xx	22, 25	EPH0500121	10	EPH1570121	11	EPH3100121	15	EPH3700121	16
EPH35002xx	22, 25	EPH0500123	10	EPH1570123	11	EPH3100123	15	EPH3700123	16
EPH35003xx	22, 25	EPH0500161	10	EPH1600121	13	EPH3100161	15	EPH3700161	16

Katalógové čísla

Index

Kat. č.	Str.	Kat. č.	Str.	Kat. č.	Str.	Kat. č.	Str.	Kat. č.	Str.
EPH3700171	16	EPH4700171	17	EPH5600171	19	EPH5800571	19	EPH6200171	11
EPH3700221	16	EPH4800121	17	EPH5700121	17	EPH5800621	19	EPH6400121	18
EPH3700223	16	EPH4800123	17	EPH5700123	17	EPH5800623	19	EPH6400123	18
EPH3700261	16	EPH4800161	17	EPH5700161	17	EPH5800661	19	EPH6400161	18
EPH3700271	16	EPH4800171	17	EPH5700171	17	EPH5800671	19	EPH6400171	18
EPH4100121	17	EPH4900121	17	EPH5800121	19	EPH5810221	19	EPH6500121	18
EPH4100123	17	EPH4900123	17	EPH5800123	19	EPH5810223	19	EPH6500123	18
EPH4100161	17	EPH4900161	17	EPH5800161	19	EPH5810261	19	EPH6500161	18
EPH4100171	17	EPH4900171	17	EPH5800171	19	EPH5810271	19	EPH6500171	18
EPH4200121	17	EPH5000121	17	EPH5800221	19	EPH5810321	19	EPH6600121	18
EPH4200123	17	EPH5000123	17	EPH5800223	19	EPH5810323	19	EPH6600123	18
EPH4200161	17	EPH5000161	17	EPH5800261	19	EPH5810361	19	EPH6600161	18
EPH4200171	17	EPH5000171	17	EPH5800271	19	EPH5810371	19	EPH6600171	18
EPH4300121	17	EPH5200121	17	EPH5800321	19	EPH6100121	19	EPH9800121	14
EPH4300123	17	EPH5200123	17	EPH5800323	19	EPH6100123	19	EPH9800123	14
EPH4300161	17	EPH5200161	17	EPH5800361	19	EPH6100161	19	EPH9900121	15
EPH4300171	17	EPH5200171	17	EPH5800371	19	EPH6100171	19	EPH9900123	15
EPH4400121	17	EPH5500121	15	EPH5800421	19	EPH6100221	19		
EPH4400123	17	EPH5500123	15	EPH5800423	19	EPH6100223	19		
EPH4400161	17	EPH5500161	15	EPH5800461	19	EPH6100261	19		
EPH4400171	17	EPH5500171	15	EPH5800471	19	EPH6100271	19		
EPH4700121	17	EPH5600121	19	EPH5800521	19	EPH6200121	11		
EPH4700123	17	EPH5600123	19	EPH5800523	19	EPH6200123	11		
EPH4700161	17	EPH5600161	19	EPH5800561	19	EPH6200161	11		

www.se.com/sk
www.mojvypinac.sk